

RF MOSFET Power Transistor, 2W, 28V

500 - 1000 MHz

LF2802A

V2.00

Features

- N-Channel Enhancement Mode Device
- DMOS Structure
- Lower Capacitances for Broadband Operation
- Common Source Configuration
- Lower Noise Floor
- Applications
 - Broadband Linear Operation
 - 500 MHz to 1400 MHz

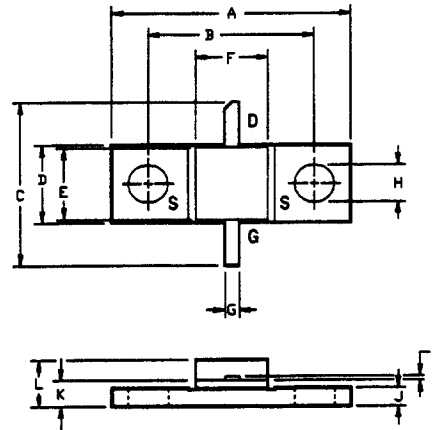

Absolute Maximum Ratings at 25°C

Parameter	Symbol	Rating	Units
Drain-Source Voltage	V_{DS}	65	V
Gate-Source Voltage	V_{GS}	20	V
Drain-Source Current	I_{DS}	0.7	A
Power Dissipation	P_D	8	W
Junction Temperature	T_J	200	°C
Storage Temperature	T_{STG}	-55 to +150	°C
Thermal Resistance	θ_{JC}	21.8	°C/W

LETTER DIM	MILLIMETERS		INCHES	
	MIN	MAX	MIN	MAX
A	20.70	20.96	.815	.825
B	14.35	14.61	.565	.575
C	13.72	14.22	.540	.560
D	6.27	6.53	.247	.257
E	6.22	6.48	.245	.255
F	6.22	6.48	.245	.255
G	1.14	1.40	.045	.055
H	2.92	3.18	.115	.125
J	1.40	1.65	.055	.065
K	1.96	2.46	.077	.097
L	3.61	4.37	.142	.172
M	.08	.15	.003	.006

Electrical Characteristics at 25°C

Parameter	Symbol	Min	Max	Units	Test Conditions
Drain-Source Breakdown Voltage	BV_{DSS}	65	-	V	$V_{GS}=0.0\text{ V}, I_{DS}=1.0\text{ mA}$
Drain-Source Leakage Current	I_{DSS}	-	0.5	mA	$V_{DS}=28.0\text{ V}, V_{GS}=0.0\text{ V}$
Gate-Source Leakage Current	I_{GSS}	-	0.5	μA	$V_{GS}=20\text{ V}, V_{DS}=0.0\text{ V}$
Gate Threshold Voltage	$V_{GS(TH)}$	2.0	6.0	V	$V_{DS}=10.0\text{ V}, I_{DS}=5.0\text{ mA}$
Forward Transconductance	G_M	40	-	mS	$V_{DS}=10.0\text{ V}, I_{DS}=50.0\text{ mA}, \Delta V_{GS}=1.0\text{ V}, 80\text{ }\mu\text{s Pulse}$
Input Capacitance	C_{ISS}	-	3.5	pF	$V_{DS}=28.0\text{ V}, F=1.0\text{ MHz}$
Output Capacitance	C_{OSS}	-	3.75	pF	$V_{DS}=28.0\text{ V}, F=1.0\text{ MHz}$
Reverse Capacitance	C_{RSS}	-	1.2	pF	$V_{DS}=28.0\text{ V}, F=1.0\text{ MHz}$
Power Gain	G_P	10	-	dB	$V_{DS}=28.0\text{ V}, I_{DQ}=25\text{ mA}, P_{OUT}=2.0\text{ W}, F=1.0\text{ GHz}$
Drain Efficiency	η_D	40	-	%	$V_{DS}=28.0\text{ V}, I_{DQ}=25\text{ mA}, P_{OUT}=2.0\text{ W}, F=1.0\text{ GHz}$
Load Mismatch Tolerance	VSWR-T	-	20:1	-	$V_{DS}=28.0\text{ V}, I_{DQ}=25\text{ mA}, P_{OUT}=2.0\text{ W}, F=1.0\text{ GHz}$

Specifications Subject to Change Without Notice.

9-68

M/A-COM, Inc.

North America: Tel. (800) 366-2266
Fax (800) 618-8883

Asia/Pacific: Tel. +81 (03) 3226-1671
Fax +81 (03) 3226-1451

Europe: Tel. +44 (1344) 869 595
Fax +44 (1344) 300 020

Typical Broadband Performance Curves

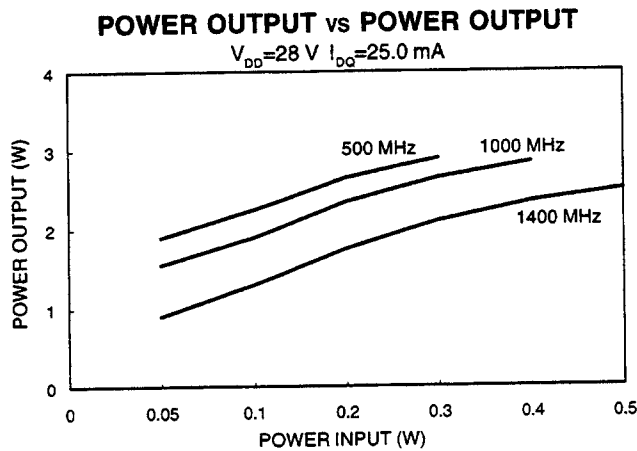
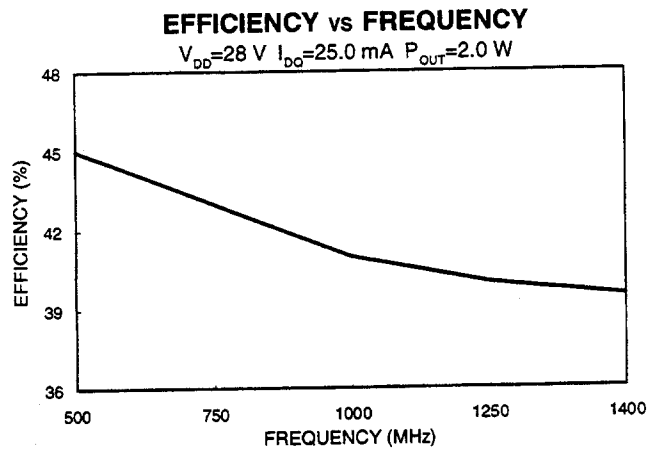
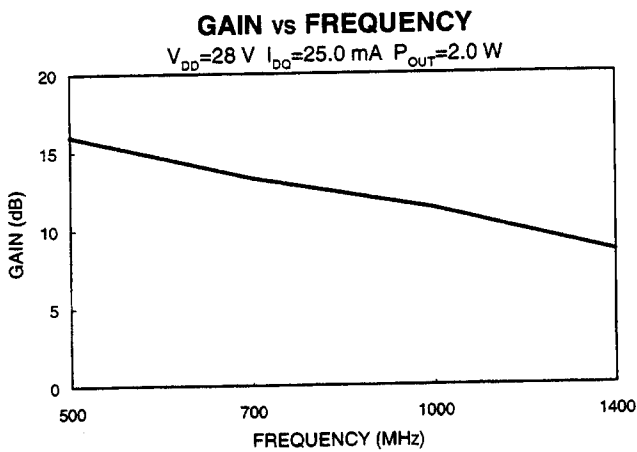
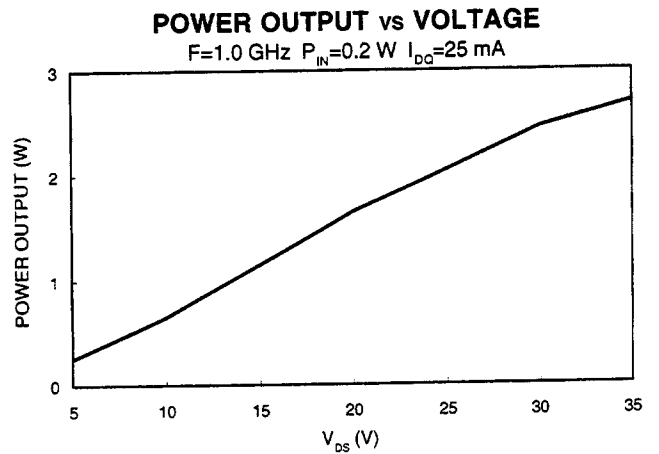
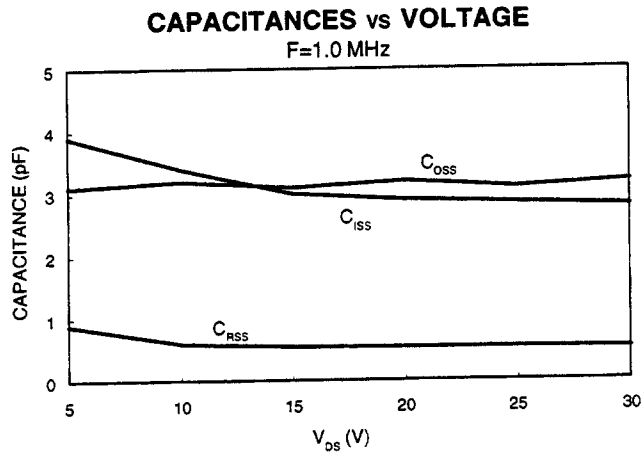

- Continued next page -

Specifications Subject to Change Without Notice.

M/A-COM, Inc.

North America: Tel. (800) 366-2266
 Fax (800) 618-8883

Asia/Pacific: Tel. +81 (03) 3226-1671
 Fax +81 (03) 3226-1451

Europe: Tel. +44 (1344) 869 595
 Fax +44 (1344) 300 020

Typical Device Impedance

Frequency (MHz)	Z _{IN} (OHMS)	Z _{LOAD} (OHMS)
500	10.0 - j 41.5	40.0 + j 53.0
1000	4.2 - j 12.0	11.85 + j 33.0
1400	3.5 - j 1.0	7.5 + j 23.3

V_{DD}=28 V, I_{DD}=25 mA, P_{OUT}=2.0 Watts

Z_{IN} is the series equivalent input impedance of the device from gate to source.

Z_{LOAD} is the optimum series equivalent load impedance as measured from drain to ground.

RF Test Fixture

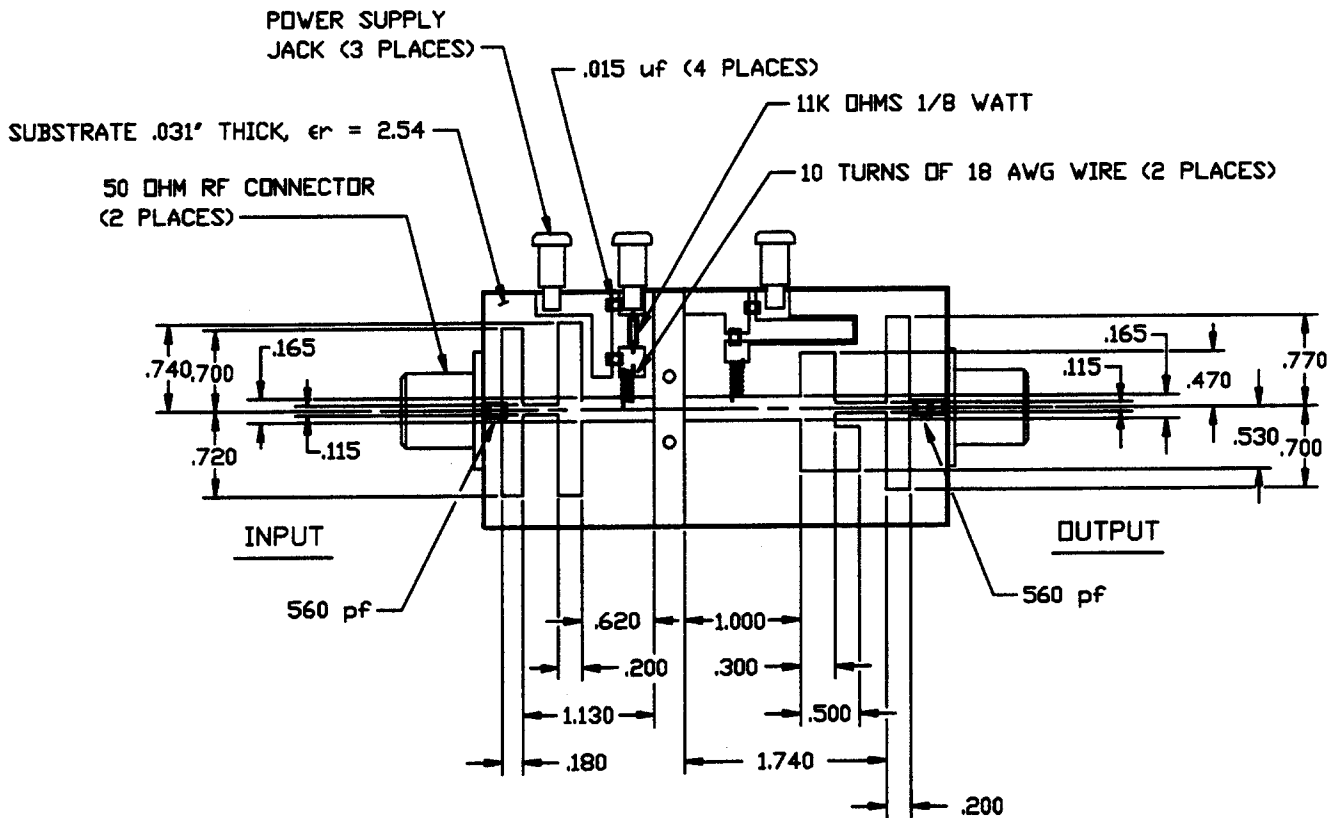

Specifications Subject to Change Without Notice.

9-70

M/A-COM, Inc.

North America: Tel. (800) 366-2266
Fax (800) 618-8883

Asia/Pacific: Tel. +81 (03) 3226-1671
Fax +81 (03) 3226-1451

Europe: Tel. +44 (1344) 869 595
Fax +44 (1344) 300 020